

YOUR GATEWAY TO A
BETTER VIEW

HS-TEC-G-050-02



H CASEMENT

FIXED PANEL & WINDOW SYSTEM

PRODUCT BROCHURE

H E R I T A G E

BY H SYSTEMS



H 28 CASEMENT SYSTEM

— HERITAGE —

BY H SYSTEMS

H 28 CASEMENT FEATURES

The H 28 Casement System is a fixed panel and window system, that is characterized by its frame width of 28mm. Its narrow sightlines enhance natural light entry while maintaining structural integrity. Engineered for performance, the H28 Casement System meets South African building standards, making it a preferred choice in the market for both residential and commercial projects.

CAPABILITIES

- The H 28 Casement System offers a variety of window configurations, including top-hung and side-hung options.
- The H 28 Casement System offers a range of adaptors that facilitate integration with patio slider sidelights and shopfronts, enhancing versatility and functionality.
- A range of three mullions (28mm, 54mm and 70mm) are available to cater for larger window openings.
- The H 28 Casement System is designed to accommodate 13mm stack height friction stays.
- A variety of cost-effective PVC gaskets are available.
- The Santoprene Gasket Range is available upon special request.

GLAZING

- The H 28 Casement System is glazed from the outside only.
- Accommodates single glazing (4mm-8.38mm) only.

COLOUR OPTIONS

- The H 28 Casement System material is stocked in mill finish, black, bronze, charcoal, white and silver.
- A wide range of custom powder coating options are available, with a minimum lead time of 15 working days. Providing you with endless possibilities to bring your vision to life.

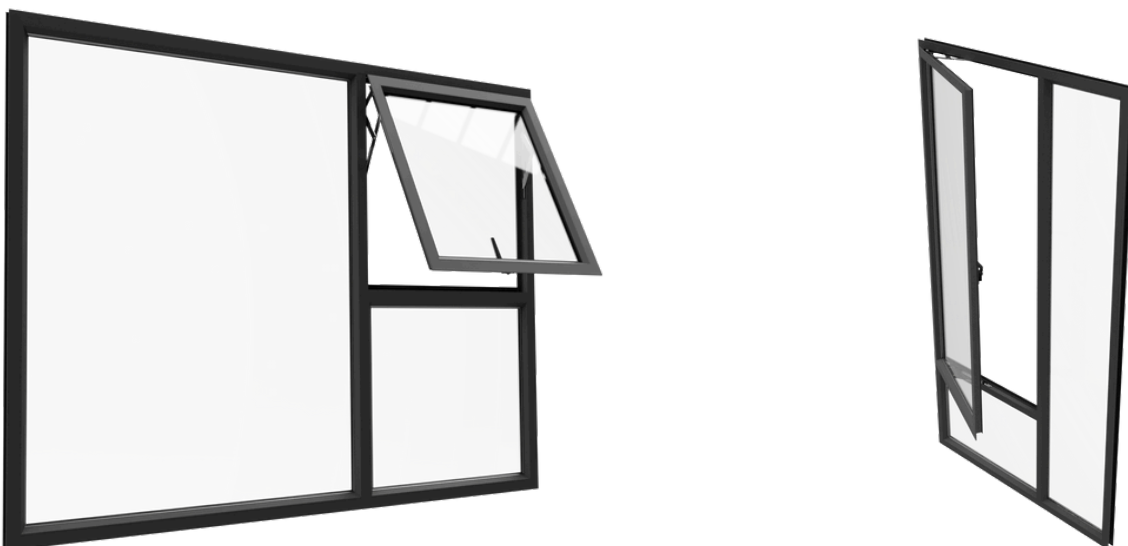

H 28 CASEMENT WALL CHART

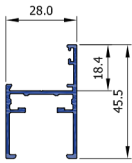

Equal Leg Frame 28
CW2840

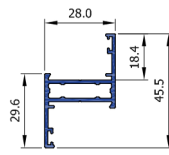

Tubular Sash 28
CW2841

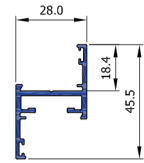

Un-equal Leg Frame STD 28
CW2816

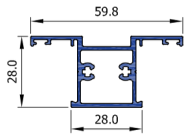

Mullion 28
CW2842

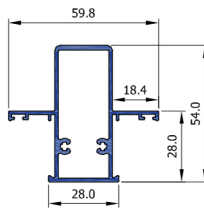

Mullion 54 28
CW2821

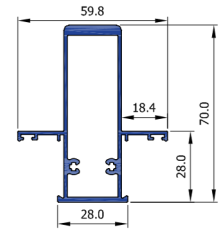

Mullion 70 28
CW2822

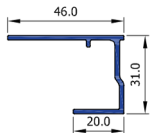

Steel Replacement Frame
CW2880



Bead 4 28
CW2814

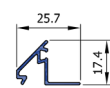

Bead Multi 28
CW2826

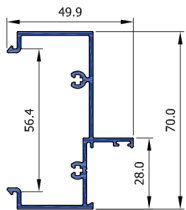

Casement Frame 70 28
CW2870

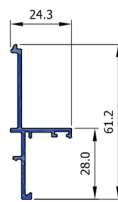

Adaptor Shopfront 28 Casement
SF44160

*Configurations are not limited to details shown. Scale: 1:3 to fit A4.

H 28 CASEMENT PRODUCT FEATURE





H 30.5 CASEMENT SYSTEM

HERITAGE
BY H SYSTEMS

H 30.5 CASEMENT FEATURES

The H 30.5 Casement System is a fixed panel and window system, that is characterized by its frame width of 30.5mm. This system is part of the extensive portfolio of aluminium window products available in South Africa, renowned for its durability. The H 30.5 is popular in residential and commercial applications, where it enhances natural light and ventilation while providing a sleek, modern look.

CAPABILITIES

- The H 30.5 Casement System offers a variety of window configurations, including top-hung and side-hung options.
- The H 30.5 Casement System offers a range of adaptors that facilitate integration with patio slider sidelights and shopfronts, enhancing versatility and functionality.
- A range of three mullions (30.5mm, 54mm and 70mm) are available to cater for larger window openings.
- The H 30.5 Casement System is designed to accommodate 13mm stack height friction stays.
- A drip transom profile is available to prevent water from dripping onto the glazing.

GLAZING

- The H 30.5 Casement System is glazed from the outside only.
- Accommodates single glazing (4mm-8.38mm).
- Accommodates double glazing (14mm-16mm).

COLOUR OPTIONS

- The H 30.5 Casement System material is stocked in mill finish, black, bronze, charcoal, white and silver.
- A wide range of custom powder coating options are available, with a minimum lead time of 15 working days. Providing you with endless possibilities to bring your vision to life.

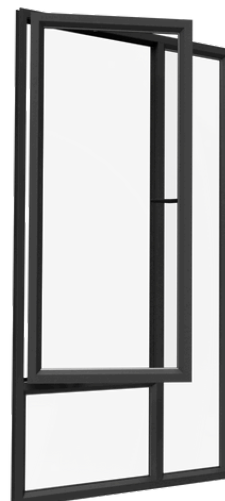

H 30.5 CASEMENT WALL CHART

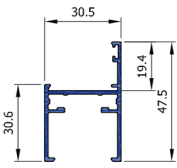

Equal Leg Frame 30.5
CW3040

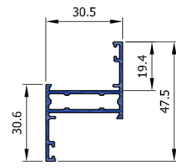

Tubular Sash 30.5
CW3041

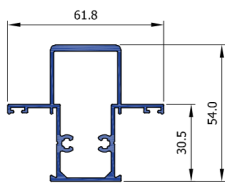

Mullion 54 30.5
CW3021

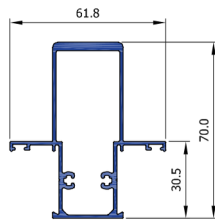

Mullion 70 30.5
CW3022

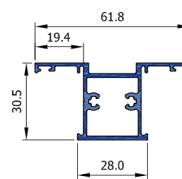

Mullion 30.5
CW3042

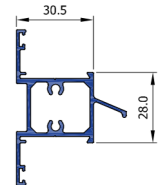

Mullion with Drip 30.5
CW3013

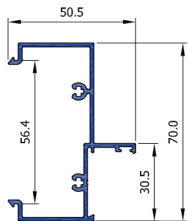

Casement Frame 70 30.5
CW3070

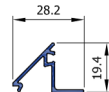

Bead 4 30.5
CW3014

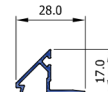

Bead 6 30.5
CW3015

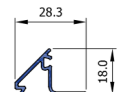

Bead Multi 26
CW3026

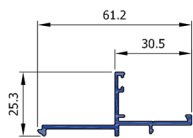

Adaptor Shopfront 30.5 Casement
SF44161

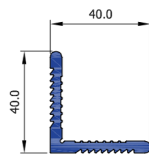

Corner Cleat Osborn
CW3017

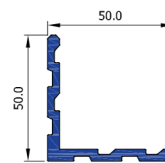

Corner Cleat 50
CW3024

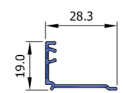

30.5 Bead Double Glazing
CW3064

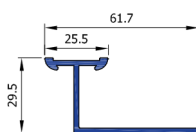

Fixing Lug Twist In
CW3027

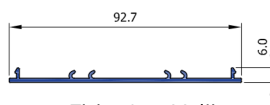

Fixing Lug Multi
CW3028

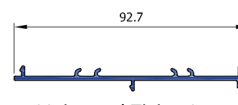

Universal Fixing Lug
SF44028

*Configurations are not limited to details shown. Scale: 1:3 to fit A4.

H 30.5 CASEMENT PRODUCT FEATURE





H 34 CASEMENT SYSTEM

HERITAGE

BY H SYSTEMS

H 34 CASEMENT FEATURES

The H 34 Casement System is a fixed panel and window system, that is characterized by its frame width of 34mm. This system is part of the extensive portfolio of aluminium window products available in South Africa, renowned for its durability. The H 34 Casement System is popular in residential applications and commercial projects due to its high quality construction and versatile design.

CAPABILITIES

- The H 34 Casement System offers a variety of window configurations, including top-hung and side-hung options.
- A range of three mullions (34mm, 54mm and 70mm) are available to cater for larger window openings.
- The H 34 Casement System is designed to accommodate 13mm stack height friction stays.
- A variety of cost-effective PVC gaskets are available.
- The Santoprene Gasket Range is available upon special request.

GLAZING

- Accommodates single glazing (4mm-8.38mm).
- Accommodates double glazing (18mm-20.76mm).

COLOUR OPTIONS

- The H 34 Casement System material is stocked in mill finish, black, bronze, charcoal, white and silver.
- A wide range of custom powder coating options are available, with a minimum lead time of 15 working days. Providing you with endless possibilities to bring your vision to life.

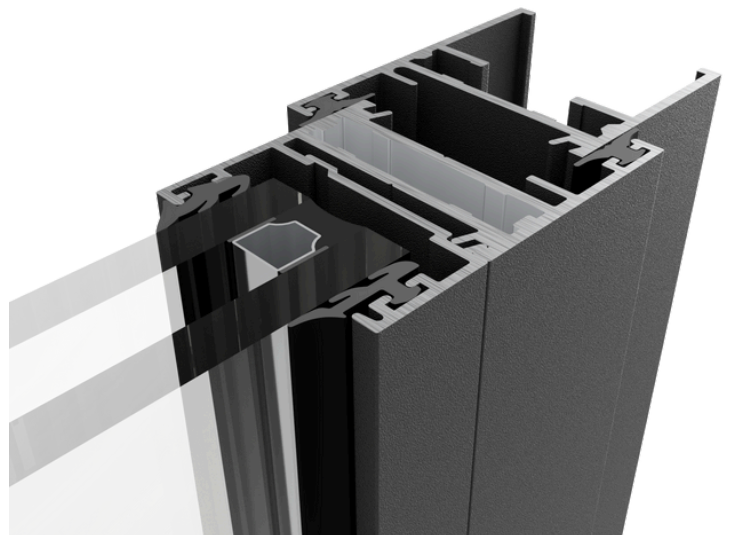

DOUBLE GLAZED SASH

H 34 CASEMENT WALL CHART

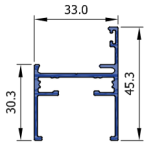

Equal Leg Frame STD 34
SCW3440

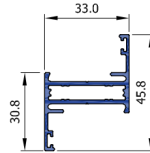

Tubular Sash STD 34
SCW3441

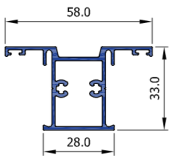

Mullion Standard 34
SCW3442

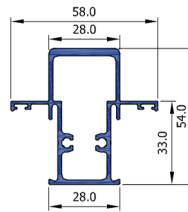

Mullion 54 34
SCW3421

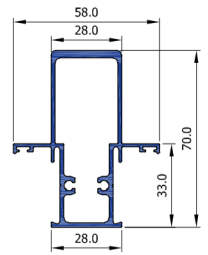

Mullion 70 34
SCW3422

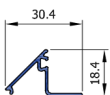

Bead Multi 34
SCW3426

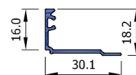

Bead Double Glazing 34
SCW3464

*Configurations are not limited to details shown. Scale: 1:3 to fit A4.

H 34 CASEMENT PRODUCT FEATURE

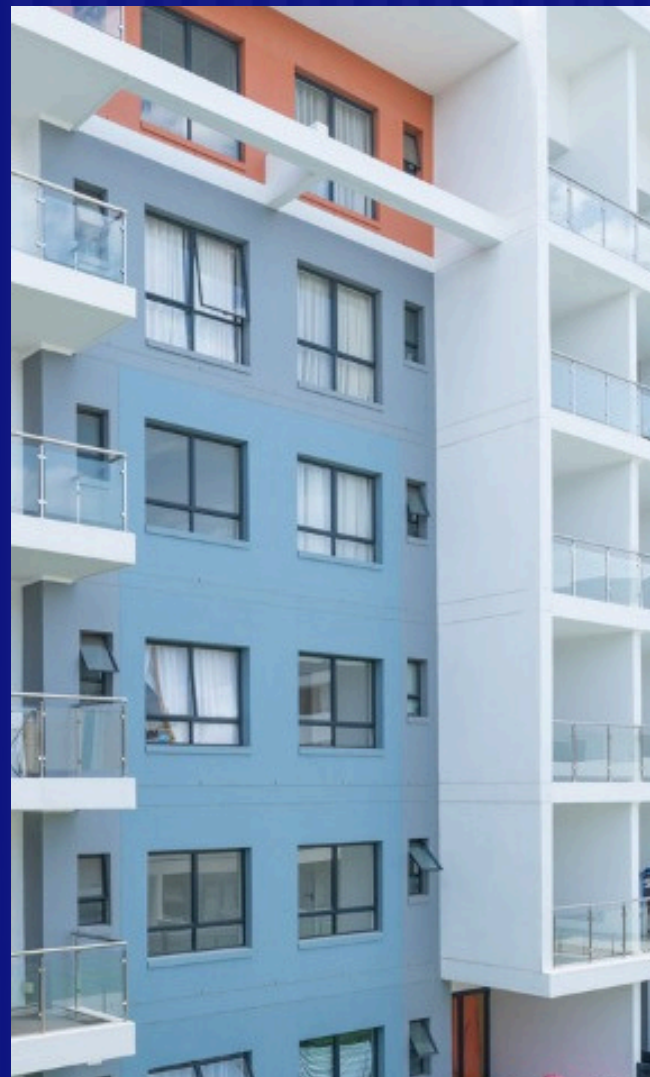



H 38 CASEMENT SYSTEM

HERITAGE

BY H SYSTEMS

H 38 CASEMENT FEATURES

The H 38 Casement System is a versatile 38mm window system, offering multiple opening configurations to suit diverse architectural needs. Its design emphasizes aesthetic flexibility, with a range of sashes and mullions that enable adaptability across various project specifications. Engineered for durability, the system is optimized for maximum performance.

CAPABILITIES

- The H 38 Casement System offers a variety of window configurations, including top-hung and side-hung options.
- Adaptors are available that enables the system to be integrated into a Shopfront or Jacaranda curtain wall.
- A range of four mullions (38mm, 54mm, 76mm and 100mm) are available to cater for larger window openings.
- The H 38 Casement System is designed to accommodate 13mm and 16mm stack height friction stays.
- Heavy duty sash can be used to accommodate larger openings.
- Sub-cill, compensating channel, cill flashing/reveal cover are available.
- A variety of cost-effective PVC gaskets are available.
- The Santoprene Gasket Range is available upon special request.

GLAZING

- Single and double flush glazing options are available.
- Accommodates single glazing: 4mm - 8.38mm (sloped bead)
- Accommodates single glazing: 6mm - 10mm (square bead)
- Accommodates double glazing: 22mm - 26.76mm

COLOUR OPTIONS

- The H 38 Casement System material is stocked in mill finish, black, bronze, charcoal, white and silver.
- A wide range of custom powder coating options are available, with a minimum lead time of 15 working days. Providing you with endless possibilities to bring your vision to life.

H 38 CASEMENT CONFIGURATIONS

DOUBLE SIDE HUNG WINDOW WITH FIXED PANEL IN A SUB-FRAME



DOUBLE GLAZED FLUSH GLAZED SASH

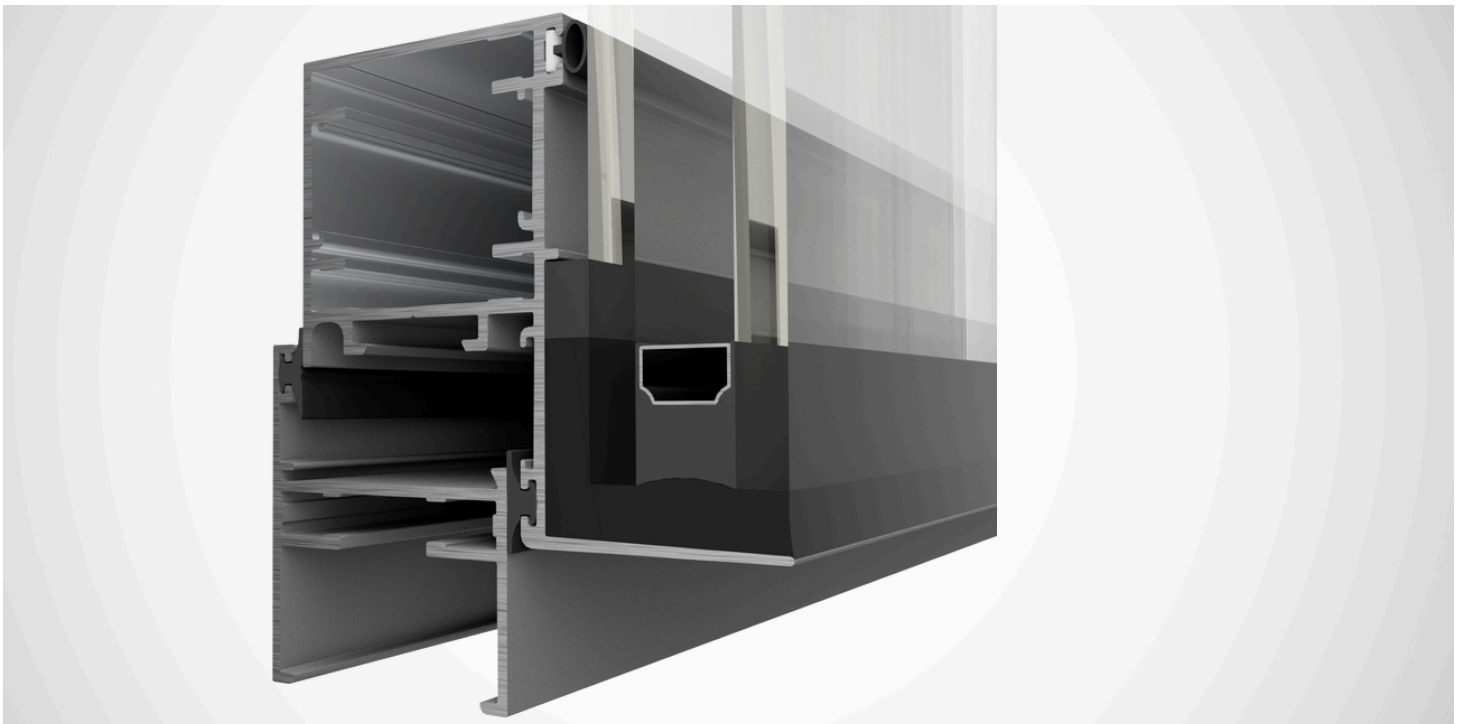

H 38 CASEMENT WALL CHART

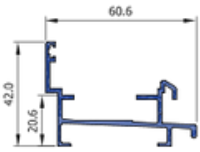

Sub Cill 38
CW3881

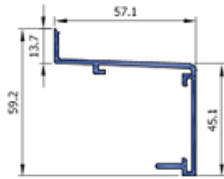

Add On Cill 38
CW3882

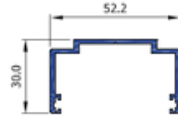

Compensating Channel 38
CW3899

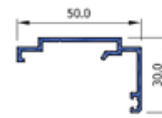

2 Part Compensating
Channel 38
CW3898A

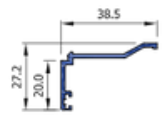

2 Part Compensating
Channel Bead 38
CW3898B

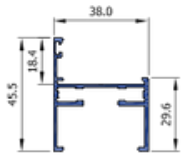

Equal Leg 38
CW3840

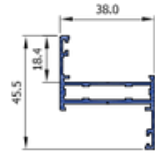

Tubular Sash STD 38
CW3841

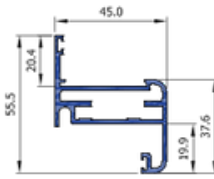

Sash HD 38
CW3892

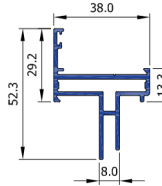

38 Casement Outer
Frame for SG PG
CUR-58311

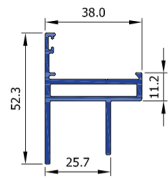

38 Casement Outer
Frame for DG PG
CUR-58312

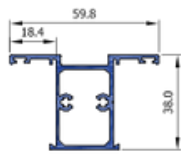

Mullion Standard 38
CW3842

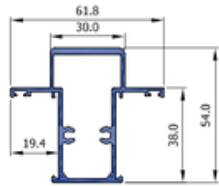

Mullion 54 38
CW3821

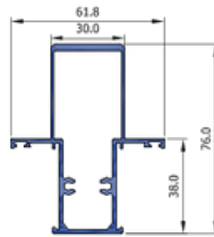

Mullion 76 38
CW3822

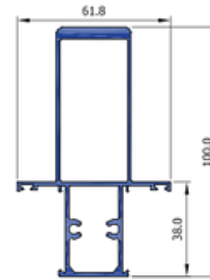

Mullion 100 38
CW3823

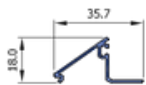

Bead Multi 38
CW3826

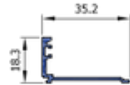

Bead Double Glazing 38
CW3864

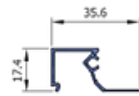

Bead Square
CW3807

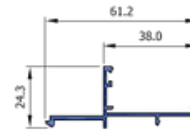

Adaptor Shopfront 38 Casement
SF44165



FG Sash Single Glazing
CW3871



FG Sash Double Glazing
CW3873



FG Fixed Panel Cover
CW3872

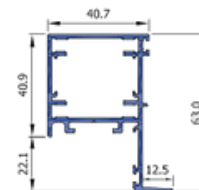

Single Flush Glazed Sash
CW3874

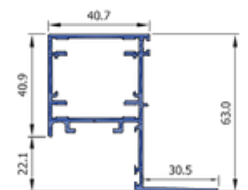

Double Flush Glazed Sash
CW3875

*Configurations are not limited to details shown. Scale: 1:3 to fit A4.

H 38 CASEMENT PRODUCT FEATURE





OUR SERVICES

HERITAGE
BY H SYSTEMS

OUR SERVICES



DRAUGHTING

H Systems offers draughting services for medium to large architectural manufacturers. We have a team of draftsmen who can produce technical plans and drawings based on the architect's plans and client specifications. The service is flexible and can be tailored to meet the specific needs of residential and commercial projects. Our service offering includes digitizing existing plans, preparing shop-drawings for architectural approval, compiling documentation, and submitting as-built drawings in a packaged format for clients to review. H Systems aims to become an effective B2B model.



ESTIMATION

Our comprehensive estimating services and software empower our clients to effortlessly generate accurate quotes for their customers and precise cutting lists for their production facilities with a single click. Our sophisticated software is designed to streamline the estimation process, eliminating manual errors and saving valuable time and resources for our valued customers.



RESEARCH & DEVELOPMENT

Our technical department, comprising of highly skilled and experienced professionals, is engaged in ongoing development of innovative systems and technical solutions that are tailored to meet the evolving needs of our valued customers. Our team stays up-to-date with the latest advancements to ensure that we can provide our customers with the most reliable and efficient solutions in the aluminium industry.



CUSTOMER TECHNICAL SUPPORT

At H Systems, we prioritize our customers' satisfaction by providing unwavering support throughout their manufacturing journey. Our dedicated technical support team is committed to delivering exceptional service, offering comprehensive assistance and training to help our customers make informed decisions when selecting the most suitable product or service tailored to their specific needs. Furthermore, our punchtools are carefully crafted to simplify the manufacturing process, ensuring ease of use and increased efficiency, allowing our customers to achieve their production goals seamlessly.

Contact our Technical Department on 011 748 2660 or technical@hsystems.co.za for any assistance or further information on the available service.

OUR SERVICES

BIZMANTOOLS ESTIMATING SOFTWARE

H Systems (Pty) Ltd has partnered with Bizmantools, in developing user-friendly software which offers our valued customers a digital platform to do the following:

bizmantools



Bizman quoting enables our valued customers, to produce quotes for their customers and cutting lists for their production facilities at the touch of a button! The feature-packed product helps manage quality and profitability whilst ensuring all work produced is NHRBC (National Home Builders Registration Council) compliant.

H Systems has identified our customers' needs with regards to cutting and estimating and encourage all our valued customers to enquire through our Technical Department (technical@hsystems.co.za), how to get Bizman Life and take their businesses to the next level.



HERITAGE BY H SYSTEMS

A range of generic systems consisting of various non-insulated doors, windows, fixed panels, fixed and ventilated louvre systems.

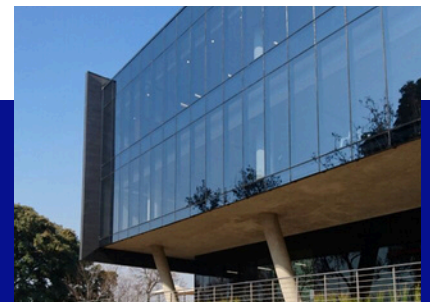

CUSTODIAN Collection BY H SYSTEMS

A range of specialized systems exclusive to H Systems consisting of thermally improved double-glazed curtainwall, non-insulated windows, doors, fixed glazing, and cladding systems.

OUR SERVICES

Window, door and curtain wall manufacturers plan and produce their products with LogiKal. LogiKal takes the user safely and efficiently through the entire process. It has never been so simple to design, estimate and produce doors, windows and curtain walls of all types and all sizes. LogiKal opens up direct and intuitive paths towards your goal.



ORGADATA

WHY LOGIKAL:

- User friendly interface.
- Personalized one on one training.
- Ongoing database updates.
- Instant help through remote support.
- Smart Measure app.
- Regular on site visits.
- Cloud solutions.
- Integration with external software.
- Information sharing & collaboration.
- Individual digitalized production.

FEATURES:

- Element Input.
- Quotation.
- Shop drawings.
- Fabrication.
- Material optimization.
- Reporting.
- Custom hardware libraries.
- Construction with CAD.
- CNC integration.
- AutoCAD & Revit plugin.



HERITAGE BY H SYSTEMS

A range of generic systems consisting of various non-insulated doors, windows, fixed panels, fixed and ventilated louvre systems.

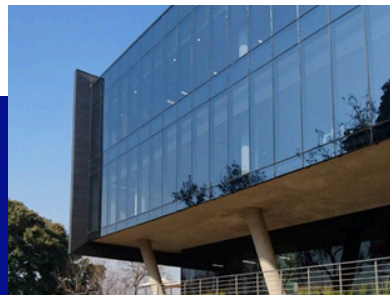

CUSTODIAN Collection BY H SYSTEMS

A range of specialized systems exclusive to H Systems consisting of thermally improved double-glazed curtainwall, non-insulated windows, doors, fixed glazing, and cladding systems.



aliplast ALUMINIUM SYSTEMS

A range of European systems imported from Belgium, comprising of thermally broken and non-insulated doors, windows and fixed panels.

PAINT & FINISHING



H Systems (Pty) Ltd has formed partnerships with different established powder coaters to provide the necessary paint and finishing services to all architectural manufacturers. H Systems and our partners offer tailored powder coating solutions to meet the specific requirements of different projects.

Powder coating architectural aluminium profiles have various benefits, including, but not limited to:

- Solvent free – No V.O.C (Volatile Organic Compounds) emission.
- Low fire hazard risk.
- Waste powder can be recycled.
- Increased durability of finishes on the final product.
- Superior corrosion resistance acting as a barrier to corrosive chemicals and moisture.
- Superior chemical resistance.
- Superior heat resistance and specifically developed for elevated temperatures.
- Superior abrasion and scratch resistance.
- Powders are formulated to withstand high impact.
- Superior quality finish.

Our flexible services mean that we can tailor make a powder coating solution to meet the specific needs of your projects.

Powder Coating specifications available:

- Various finishes (matt, gloss, or satin).
- Various classifications (D1001, D1025, D1036 & D2525).
- Various colours.
- Akzo Nobel or Ferro product categories.

Powder coating has a minimum lead time of 15 working days.

PAINT OPTIONS



Black (BE)



Charcoal (CH)



Bronze (BZE)



White (WE)



Silver (SE)



Mill



Bespoke Colours

PRODUCT FEATURE



Our Footprint



Gauteng (Johannesburg)

206 R23 Road, Bredell Ext 26,
Kempton Park, Gauteng, 1619
+27 11 748 2660

Western Cape (Cape Town)

Unit 2, Corner of Buttskop Road & Range Road,
Kwela Park, Blackheath, Cape Town, 7581
+27 21 905 0005

KwaZulu-Natal (EThekwini)

Unit 11, Vision Business Park, 5 Tottum Rd,
Cornubia, EtheKwini, 4001
+27 31 569 2275

Mpumalanga (Nelspruit)

Unit 2, Glassfit Building, 8 Stinkhout Crescent,
Nelspruit, Mpumalanga, 1201
+27 13 752 7565

Eastern Cape (Gqeberha)

11 Nicoll Road, Korsten, Gqeberha,
Eastern Cape, 6001
+27 41 451 1642

Limpopo (Polokwane)

Nkahloleng St Polokwane Ext 42,
Polokwane, 0700
+27 15 001 2604

Technical Department

206 R23 Road, Bredell Ext 26,
Kempton Park, Gauteng, 1619
+27 11 748 2660
technical@hsystems.co.za

Debtors Department

+27 33 386 1422/24

